

Hafa® Glacier 2D

Art: 1472200, 1472205, 1472210, 1472215, 1472220,
1472225, 1472230, 1472300, 1472305, 1472310,
1472315, 1472320, 1472325, 1472330

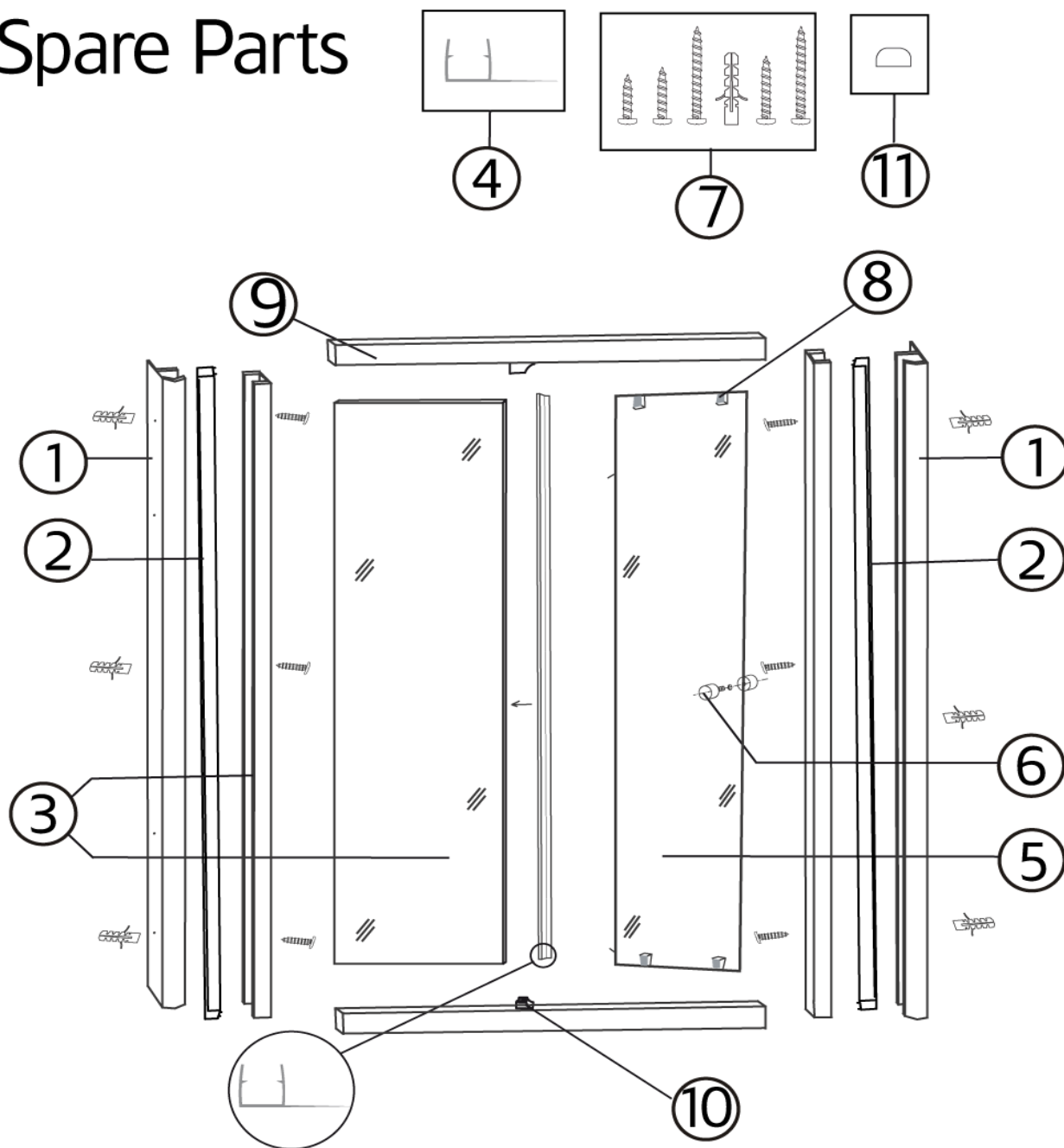

Spare Parts



Hafa®

Hafa
Svarvaregatan 5, Box 525
SE-301 80 Halmstad
SWEDEN

www.hafa.se
www.hafa.dk
www.hafabad.no
www.hafa.fi
www.hafabathroom.ru
www.hafa.eu

E-mail:
service@hafa.se

Hafa® Glacier 2D

Art: 1472200, 1472205, 1472210, 1472215, 1472220,
1472225, 1472230, 1472300, 1472305, 1472310,
1472315, 1472320, 1472325, 1472330

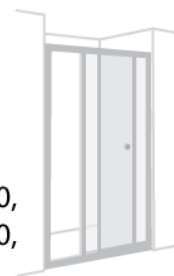

SKETCH NO:	SPAREPART NO.	GLACIER DUSCHDÖRR 2D	GLACIER SHOWER DOOR 2D	PHOTO
1	9306090	GLACIER 2D VÄGGPROFIL	GLACIER 2D WALL PROFILE	
2	1472295	FÖRL.PROFIL GLACIER 2D	EXTENSION.PROFILE GLACIER 2D	
3	9306091	GLAC 2D 900 SIDOGLAS+PROFIL T	GLAC 2D 900 SIDE GLASS+PRO C	
	9306092	GLAC 2D 975/1725 SIDOGLAS+PRO T	GLAC 2D 975/1725 S.GLASS+PR C	
	9306093	GLAC 2D 1050/1125SIDOGLAS+PRO T	GLAC 2D 1050/1125 S.GLASS+PR C	
	9306094	GLAC 2D 1200/1275SIDOGLAS+PRO T	GLAC 2D 1200/1275 S.GLASS+PR C	
	9306095	GLAC 2D 1350 SIDOGLAS+PRO T	GLAC 2D 1350 SIDE GLASS+PR C	
	9306096	GLAC 2D 1425/1500SIDOGLAS+PRO T	GLAC 2D 1425/1500 S.GLASS+PR C	
	9306097	GLAC 2D 1575/1650SIDOGLAS+PRO T	GLAC 2D 1575/1650 S.GLASS+PR C	
3	9306098	GLAC 2D 900 SIDOGLAS+PROFIL SM	GLAC 2D 900 SIDEGLASS+PRO SM	
	9306099	GLAC 2D 975/1725 SIDOGLAS+PROFIL SM	GLAC 2D 975/1725S.GLASS+PR SM	
	9306100	GLAC 2D 1050/1125 SIDOGLAS+PROFIL SM	GLAC 2D 1050/1125S.GLASS+PR SM	
	9306101	GLAC 2D 1200/1275 SIDOGLAS+PROFIL SM	GLAC 2D 1200/1275S.GLASS+PR SM	
	9306102	GLAC 2D 1350 SIDOGLAS+PROFIL SM	GLAC 2D 1350 S.GLASS+PRO SM	
3	9306103	GLAC 2D 1425/1500 SIDOGLAS+PROFIL SM	GLAC 2D 1425/1500S.GLASS+PR SM	
	9306104	GLAC 2D 1575/1650 SIDOGLAS+PROFIL SM	GLAC 2D 1575/1650S.GLASS+PR SM	
4	9306074	GLACIER/ICELAND/POLARIS VÄGGLIST 1775x10MM	GLACIER/ICELAND/POLARIS WALL GASKET 1775x10MM	

Hafa®

Hafa
Svarvaregatan 5, Box 525
SE-301 80 Halmstad
SWEDEN

www.hafa.se
www.hafa.dk
www.hafabad.no
www.hafa.fi
www.hafabathroom.ru
www.hafa.eu

E-mail:
service@hafa.se

Hafa® Glacier 2D

Art: 1472200, 1472205, 1472210, 1472215, 1472220,
1472225, 1472230, 1472300, 1472305, 1472310,
1472315, 1472320, 1472325, 1472330

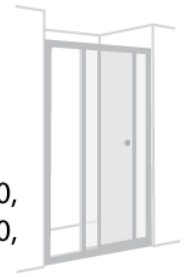

SKETCH NO:	SPAREPART NO.	GLACIER DUSCHDÖRR 2D	GLACIER SHOWER DOOR 2D	PHOTO	
5	9306106	GLACIER 2D 900/1725 DÖRR T NY MODELL	GLACIER 2D 900/1725 GLASS DOOR		
	9306107	GLACIER 2D 975/1050 DÖRR T NY MODELL	GLACIER 2D 975/1050 GLASS DOOR		
	9306108	GLACIER 2D 1125/1200 DÖRR T NY MODELL	GLACIER 2D 1125/1200 GLASS DOOR		
	9306109	GLACIER 2D 1275/1350 DÖRR T NY MODELL	GLACIER 2D 1275/1350 GLASS DOOR		
	9306110	GLACIER 2D 1425 DÖRR T NY MODELL	GLACIER 2D 1425 GLASS DOOR		
	9306111	GLACIER 2D 1500/1575 DÖRR T NY MODELL	GLACIER 2D 1500/1575 GLASS DOOR		
	9306112	GLACIER 2D 1650 DÖRR T NY MODELL	GLACIER 2D 1650 GLASS DOOR		
	9306113	GLACIER 2D 900/1725 DÖRR T G:A MODELL	GLACIER 2D900/1725GL.DOOR OLD		
	9306114	GLACIER 2D 975/1050 DÖRR T G:A MODELL	GLACIER 2D975/1050GL.DOOR OLD		
	9306115	GLACIER 2D 1125/1200 DÖRR T G:A MODELL	GLACIER 2D1125/1200GL.DOOR OLD		
	9306116	GLACIER 2D 1275/1350 DÖRR T G:A MODELL	GLACIER 2D1275/1350GL.DOOR OLD		
	9306117	GLACIER 2D 1425 DÖRR T G:A MODELL	GLACIER 2D 1425 GL.DOOR OLD		
	9306118	GLACIER 2D 1500/1575 DÖRR T G:A MODELL	GLACIER 2D1500/1575GL.DOOR OLD		
	9306119	GLACIER 2D 1650 GLAS DÖRR T G:A MODELL	GLACIER 2D1650GL.DOOR OLD		
	5	9306120	GLACIER 2D 900/1725 DÖRR SM NY MODELL		GLACIER 2D 900/1725 GL.DOOR SM
		9306121	GLACIER 2D 975/1050 DÖRR SM NY MODELL		GLACIER 2D 975/1050 GL.DOOR SM
		9306122	GLACIER 2D 1125/1200 DÖRR SM NY MODELL		GLACIER 2D 1125/1200 GL.DOOR SM
		9306123	GLACIER 2D 1275/1350 DÖRR SM NY MODELL		GLACIER 2D 1275/1350 GL.DOOR SM
		9306124	GLACIER 2D 1425 DÖRR SM NY MODELL		GLACIER 2D 1425 GL.DOOR SM
9306125		GLACIER 2D 1500/1575 DÖRR SM NY MODELL	GLACIER 2D 1500/1575 GL.DOOR SM		
9306126		GLACIER 2D 1650 DÖRR SM NY MODELL	GLACIER 2D 1650 GL.DOOR SM		
9306127		GLACIER 2D 900/1725 DÖRR SM G:A MODELL	GLACIER 2D900/1725DOOR OLD SM		
9306128		GLACIER 2D 975/1050 DÖRR SM G:A MODELL	GLACIER 2D975/1050DOOR OLD SM		
9306129		GLACIER 2D 1125/1200 DÖRR SM G:A MODELL	GLACIER 2D1125/1200DOOR OLD SM		
9306130		GLACIER 2D 1275/1350 DÖRR SM G:A MODELL	GLACIER 2D1275/1350DOOR OLD SM		
9306131		GLACIER 2D 1425 DÖRR SM G:A MODELL	GLACIER 2D 1425 DOOR OLD SM		
9306132		GLACIER 2D 1500/1575 DÖRR SM G:A MODELL	GLACIER 2D1500/1575DOOR OLD SM		
9306133		GLACIER 2D 1650 DÖRR SM G:A MODELL	GLACIER 2D1650 DOOR OLD SM		
6	9306076	GLACIER HANDTAG METALL	GLACIER HANDLE METAL		
7	9306134	GLACIER 2D MONTERING.SET	GLACIER 2D MOUNT.SET		
8	9306377	GLACIER 2D ÖVRE HJUL METALL NY MODELL	POLARIS UPPER WHEELS METAL NEW MODEL		
8	9306378	GLACIER 2D NEDRE HJUL METALL NY MODELL	POLARIS LOWER WHEELS METAL NEW MODEL		

Hafa®

Hafa
Svarvaregatan 5, Box 525
SE-301 80 Halmstad
SWEDEN





www.hafa.se
www.hafa.dk
www.hafabad.no
www.hafa.fi
www.hafabathroom.ru
www.hafa.eu

E-mail:
service@hafa.se

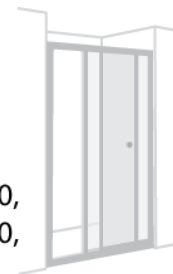
Hafa® Glacier 2D

Art 1472200, 1472205, 1472210, 1472215, 1472220,
1472225, 1472230, 1472300, 1472305, 1472310,
1472315, 1472320, 1472325, 1472330



SKETCH NO:	SPAREPART NO.	GLACIER DUSCHDÖRR 2D	GLACIER SHOWER DOOR 2D	PHOTO
8	9306379	GLACIER 2D TÄCKLOCK TILL HJUL NY MODELL	POLARIS COVER FOR WHEEL NEW MODEL	
8	9306002	GLACIER 2D, C. NEDRE HJULSET 6MM FÖR DÖRRAR SÅLDA INNAN 2010-06	GLACIER 2D, C LOWER SET WHEEL FOR DOORS BEFORE 2010-06	
	9306180	GLACIER 2D, C ÖVRE HJULSET 6MM FÖR DÖRRAR SÅLDA INNAN 2010-06	GLACIER 2D C OLD UPPER WHEEL METAL FOR DOORS BEFORE 2010-06	
9	9306136	GLACIER 2D 900 DIAGONALPROFIL HÖGER	GLACIER 2D 900 DIAGON.PROFILE RI	
	9306137	GLACIER 2D 900 DIAGONALPROFIL VÄNSTER	GLACIER 2D 900 DIAGON.PROFILE LE	
	9306138	GLACIER 2D 975 DIAGONALPROFIL HÖGER	GLACIER 2D 975 DIAGON.PROFILE RI	
	9306139	GLACIER 2D 975 DIAGONALPROFIL VÄNSTER	GLACIER 2D 975 DIAGON.PROFILE LE	
	9306140	GLACIER 2D 1050 DIAGONALPROFIL HÖGER	GLACIER 2D 1050 DIAGON.PROFILE RI	
	9306141	GLACIER 2D 1050 DIAGONALPROFIL VÄNSTER	GLACIER 2D 1050 DIAGON.PROFILE LE	
	9306142	GLACIER 2D 1125 DIAGONALPROFIL HÖGER	GLACIER 2D 1125 DIAGON.PROFILE RI	
	9306143	GLACIER 2D 1125 DIAGONALPROFIL VÄNSTER	GLACIER 2D 1125 DIAGON.PROFILE LE	
	9306144	GLACIER 2D 1200 DIAGONALPROFIL HÖGER	GLACIER 2D 1200 DIAGON.PROFILE RI	
	9306145	GLACIER 2D 1200 DIAGONALPROFIL VÄNSTER	GLACIER 2D 1200 DIAGON.PROFILE LE	
	9306146	GLACIER 2D 1275 DIAGONALPROFIL HÖGER	GLACIER 2D 1275 DIAGON.PROFILE RI	
	9306147	GLACIER 2D 1275 DIAGONALPROFIL VÄNSTER	GLACIER 2D 1275 DIAGON.PROFILE LE	
	9306148	GLACIER 2D 1350 DIAGONALPROFIL HÖGER	GLACIER 2D 1350 DIAGON.PROFILE RI	
	9306149	GLACIER 2D 1350 DIAGONALPROFIL VÄNSTER	GLACIER 2D 1350 DIAGON.PROFILE LE	
	9306150	GLACIER 2D 1425 DIAGONALPROFIL	GLACIER 2D 1425 DIAGON.PROFILE	
	9306151	GLACIER 2D 1500 DIAGONALPROFIL	GLACIER 2D 1500 DIAGON.PROFILE	
9306152	GLACIER 2D 1575 DIAGONALPROFIL	GLACIER 2D 1575 DIAGON.PROFILE		
9306153	GLACIER 2D 1650 DIAGONALPROFIL	GLACIER 2D 1650 DIAGON.PROFILE		
9306154	GLACIER 2D 1725 DIAGONALPROFIL	GLACIER 2D 1725 DIAGON.PROFILE		
10	9306155	GLACIER 2D GLASHÅLLARE	GLACIER 2D GLASS HOLDER	
11	9306089	GLAC/ICE/CLEA/POL DÖRRSTOPP	GLAC/ICE/CLEAR/POL DOOR STOPPER	

Hafa®

Hafa
Svarvaregatan 5, Box 525
SE-301 80 Halmstad
SWEDEN

www.hafa.se
www.hafa.dk
www.hafabad.no
www.hafa.fi
www.hafabathroom.ru
www.hafa.eu

E-mail:
service@hafa.se